



INTERNATIONAL DOCK PRODUCTS, INC.

EVERY ACCESSORY FOR TODAY'S DOCK, EXCEPT THE BOAT!



MARINA & BOATYARD SHORE POWER CENTER
Type 3R 200 Amps Per Side Max.
MODEL SP-C-36-1A
Suitable for use only as Marina & Boatyard Service Equipment
Power Shock Surge Protection 120 In. L.R.
Short Circuit Withstand Rating 10,000 Amps RMS 240 VAC
(Replacement of CB must be same 10,000 Amps RMS 240 VAC Rating)
INTERNATIONAL DOCK PRODUCTS, INC.
S. KING FULTON, INC.
3101 SW 25th STREET - BAY 106
PEMBROKE PARK, FL 33009
(800) 909-DOCK (954) 964-5315

WARNING - TO PREVENT ELECTRICAL SHOCK,
DO NOT REMOVE THIS COVER. REFER SERVICE
TO QUALIFIED ELECTRICIANS ONLY.

PRODUCT CATALOG

LADDERS

POWER PEDESTALS

FLEXMASTER DOCK FENDERS

ACCESSORIES

CLEATS

PILING CAPS

LINE HOLDERS

HOSE HOLDERS

WATER STANCHIONS



POWER PEDESTALS

PEDESTAL FEATURES

- Electric meters with digital readout optional on most models
- Cable TV and Phone outlets optional on most models
- Choose Fluorescent or LED lighting option
- Lighting option includes dusk-to-dawn photocell
- Single or dual ¼ turn ball cock style hose bibs using standard ¾" connections available
- Optional Shore Cord/Water Hose hanger keeps dock clutter free
- Connect multiple pedestals in series with optional loop distribution block
- Feed wires up through bottom of pedestal and connect using full access panel
- Seamless extruded aluminum case powder coated inside and out
- White powder coating is standard with many color options available
- 15-year unconditional warranty on structural integrity of the casing
- 2-year unconditional warranty on construction and fabrication of casings

21" PILING MOUNT

Our 21" pedestal (SPC-21) is designed to be mounted on a vertical surface (round or square dock piling or wall) as the ultimate space saver. This compact model can accommodate 3 outlets, plus a light with photocell. It has optional mounting brackets to fit either round or flat surfaces (specify when ordering), and comes with weather resistant thermoplastic outlet covers from Hubbell Marine.

Dimensions: 6" x 6" x 21"



36" DOCK MOUNT

Our 36" pedestal (SPC-36) is designed to be mounted vertically on the dock. The slim profile will accommodate a variety of outlets and accessories. The SPC-36 comes in two models, a 'T' series with outlets mounted at a 90-degree angle with Hubbell Thermoplastic covers, and an 'A' series with outlets mounted at a 45 degree down angle with aluminum powder coated covers to match the pedestal. Use the pedestal selection guide at www.dockproducts.com to help find the model best suited for your needs.

Dimensions: 6" x 6" x 36"



RECEPTACLES PROTECTED BY INDIVIDUAL SQ-D CIRCUIT BREAKERS

STANDARD, GFCI, AND EPD CIRCUIT BREAKERS ARE AVAILABLE



HOSE / CABLE HOLDERS AVAILABLE ON 36" MODELS AND UP



POWER PEDESTALS

41" DOCK MOUNT

Our 41" pedestal (SPB-41) is designed to be mounted vertically on the dock. The wider profile accommodates 100 Amp single and three phase for larger boats, standard outlets and all our accessories and meters. A great choice for marinas the SPB-41 comes in two models, a 'T' series with outlets mounted at a 90-degree angle with Hubbell Thermoplastic covers, and an 'A' series with outlets mounted at a 45 degree down angle with aluminum powder coated covers to match the pedestal. Use the pedestal selection guide at www.dockproducts.com to help find the model best suited for your needs.

Dimensions: 8" x 8" x 41"

**RECEPTACLES PROTECTED BY INDIVIDUAL
SQ-D CIRCUIT BREAKERS**

**STANDARD, GFCI, AND EPD
CIRCUIT BREAKERS ARE AVAILABLE**



**HOSE / CABLE HOLDERS AVAILABLE
ON 36" MODELS AND UP**



PEDESTAL FEATURES AND OPTIONS

PRECISION CONSTRUCTION

State-of-the-art robotic welding allows International Dock to respond quickly to the needs of our customers. With this technology we can accurately and consistently complete as many as 10 individual welds per minute resulting in better inventory control at lower costs. Meeting or exceeding our customer's expectations for on time delivery of quality products at competitive pricing is always our goal.



CUSTOM CNC

Every dock power pedestal we make is made to order. With our in-house CNC (Computer Numerical Control) machine we precisely cut and drill every opening needed in the aluminum casing prior to welding on necessary spacers and brackets and prior to the powder coating process.

Every outlet, breaker, light and meter fits exactly as specified each and every time. We can customize the placement of your outlets to make your docking experience as convenient as possible. When ordering, you can request which outlet you need to be on the right or left, top or bottom.

Contact our sales team to learn more about how we can build the best power pedestal on the market for you.

CUSTOM POWDERCOAT

All International Dock Power Pedestals are meticulously powder colored both inside and outside. Prior to the powder coating process all cutting, welding and drilling is completed to provide maximum protection to the aluminum extrusion. Our pedestals come standard in a glossy white finish, but we do have the ability to offer custom colors to meet your needs.



REMOTE MONITORING

Marinas are increasingly looking for ways to reduce costs and grow efficiency. International Dock uses "Marine Sync" technology to connect the dockmaster to his power pedestals through the Internet. The cloud based system features:

- Ground fault detection
- Electricity monitoring
- Water control
- Power control
- Water usage monitoring
- Lighting control



Compatible with most Marina Software Solutions.

FIELD SERVICABLE

We offer replacement parts for all of our current pedestal models. Circuit breakers, bulbs, aluminum covers, outlets, lens plates and access covers are just some of what we have available. A qualified electrician will find repairs are quick and easy through our convenient access panels on every model.

WIDE STEP MODELS SHOWN



POWER PEDESTAL OPTIONS

RECEPTACLES AND CIRCUIT BREAKERS - All S. King Fulton Power Centers use Marine grade receptacles and are available in 20 Amp, 30 Amp and 50 Amp 125 volt twist-lock, 50 Amp 125/250 volt twist-lock, 100 Amp 125/250 volt pin-and-sleeve (single phase) and 100 Amp 120/208 volt pin-and- sleeve (three phase). We also can provide 100 Amp or 200 Amp, 480 volt three phase pin and sleeve receptacles. In addition, 20 Amp duplex straight-blade GFCI receptacles are available as a convenience outlet. Each receptacle is protected by an individual SQ-D circuit breaker located on the front of the unit under one powder coated aluminum cover. Lockable covers are available.

RECEPTACLE COVERS - All receptacles are covered for protection when not in use (receptacles are designed to be water-tight when in use). There are two different types of covers:

“A”TYPE - Powder coated aluminum covers that allow the receptacles to be mounted at a 45° down angle (not available on piling mounted power centers). Lockable covers are available.

“T”TYPE –Thermo plastic covers where the receptacles are mounted flush with the casing.

ELECTRIC METERS - Available on all power centers and have the ability of metering up to six receptacles individually.

TELEPHONE - Each power center is available with up to four telephone jacks (data jacks also available –Cat 5/ Cat 6).

CABLE TV - Each power center is available with up to four cable TV jacks.

LIGHTING - Each power center is available with fluorescent or LED lighting. The light can be wired to an installed photocell or to a separate circuit to allow for manual operation. Amber lighting is available. A horizontal louver is available over the light lens for down-angled lighting.

HOSE BIBS - The standard and slim-line models are available with up to two hose bibs using standard 3/4” connections or optional lockable ball valves. The standard hose bib is a 1/4 turn Sillcock. (Hose bibs are not available on the piling mounted power centers.)

WATER METERS - Up to two internally mounted water meters available on Standard and Double dockside units only.

HOSE/CABLE HOLDERS - The Standard, Slimline, and Double models are available with up to two hose/ cable holders which allow the docks to be free of dangerous obstacles such as water hoses or ship-to-shore cables.

POWER DISTRIBUTION BLOCKS - Each power center comes pre-wired with a power distribution block and is available in direct (home run) or loop (series) feed. Maximum wire size is 500 MCM.

MATERIAL - Extruded aluminum-all one piece- no seams.

FASTENERS - Stainless Steel screws are used with nylon washers.

FINISH - Pedestals are powder coated white inside and out. Custom colors are available.

RATING - 200 Amps per side. 400 Amps total for the pedestal.

FULLY LISTED - Meets or exceeds all requirements for UL 231, NFPA 303, and the NFPA 70 National Electrical code Article 555

INSTALLATION -The Double, Standard, and Slimline Power Centers are designed to be mounted directly to the deck or the dock. A 1/8” gasket for the bottom of the pedestal is supplied. Base templates are available. The Pile Mount unit is designed for mounting on a bulkhead or a pile. You must specify whether you need flat or round brackets.

WARRANTY

- 15 year unconditional on structural integrity of 100% aluminum casing
- 2 year unconditional on construction and fabrication of casing and covers



SPC-36-3A

POWER CENTER FEATURES												
FEATURE	DOUBLE			STANDARD			SLIMLINE			PILING STYLE / WALL MOUNTED		
ALUMINUM THICKNESS	3/16"			3/16"			1/8"			1/8"		
DIMENSIONS	DEEP 8"	WIDE 16"	TALL 41" 45" 48"	DEEP 8"	WIDE 8"	TALL 41" 45" 48"	DEEP 6"	WIDE 6"	TALL 36"	DEEP 6"	WIDE 6"	TALL 21"
MAXIMUM RECEPTACLES	8			6			4			3		
MAXIMUM C.B. POLES	16			9			6			6		

CUSTOM HEIGHTS AVAILABLE

VISIT OUR WEBSITE AT DOCKPRODUCTS.COM FOR MORE DETAIL AND SPECIFICATIONS





**INTERNATIONAL
DOCK PRODUCTS, INC.**

POWER PEDESTAL SELECTION GUIDE

SPC-21-2T
HANG ON A ROUND PILE
OR FLAT VERTICAL SURFACE



SPC-36-4T
SLIMLINE DOCKSIDE
DECK MOUNT INSTALLATION



SPB-41-4A
STANDARD DOCKSIDE
DECK MOUNT INSTALLATION



OUTLETS

Choose up to 3 outlets
Installed 90 degrees to vertical

REQUEST A QUOTE

CHOOSE ONE	
SPC-21-T	
SPC-36-A	
SPC-36-T	
SPB-41-A	
SPB-41-T	
CHOOSE REQUIRED OUTLETS	
AMPERAGE	QUANTITY
20 AMP GFI	
30 AMP TWIST	
50 AMP TWIST	
OPTIONS	QUANTITY
Flourescent Light	
LED Light	
Hose outlet*	
Hose holder*	
Cable TV	

*NA on SPC-21

DECK MOUNT PEDESTAL OUTLET CONFIGURATION

Multiple outlet configurations are available for deck mount models
Choose any combination, up to four 20, 30, or 50 amp outlets

A SERIES

Outlets mounted at convenient 45 degree angle
Reduced stress on cable connections
Outlet covers powder coated aluminum to match pedestal
See SPC-36-4T pedestal drawing above

T SERIES

Outlets mounted at 90 degrees to vertical
Outlet covers weather tight yellow thermoplastic
A lower price option, with the same quality internal wiring
See SPB-41-4A pedestal drawing above

ALSO AVAILABLE:

Pedestals to accomodate 100 AMP, direct and loop feed capabilities,
water and power metering.

NAME: _____ PHONE: _____
EMAIL: _____



LADDERS

STRAIGHT LADDER 3-7 STEPS

This is our #1 selling ladder. Sometimes referred to as a standard ladder, a seawall ladder, or a straight ladder, it can be used on virtually any dock. Available from 3 to 7 steps with our standard 2" wide step or our optional 4" wide step, it is a favorite for marinas, yacht clubs and boat yards.



FEATURES & BENEFITS

- Fabricated from marine grade 6063 T5 aluminum
- Each step extends the ladder 12" down from the dock
- Available in 5 lengths from 3 to 7 steps
- Custom lengths available, contact customer service
- Standard with 2" wide steps or optional 4" wide steps
- Steps 16" wide for stability and comfort
- Step design channels away water for superior grip
- Robotic welding for faster manufacturing without sacrificing quality
- Ladders rated at 665 lb. capacity
- Optional Quick Release Kit available for easy removal without tools
- Optional boxed version to meet UPS requirements at the lowest cost

**MARINA, YACHT CLUB AND CONDO ASSOCIATION
VOLUME DISCOUNTS AVAILABLE**

SWING LADDER 3-7 STEPS

Swing ladders, or swing-up ladders as they are sometimes referred to, are similar to our straight ladders with the added feature of a pivot bracket that allows the user to pull or "pivot" the entire ladder out of the water. The ladder will stand vertically out of the water with the aid of a stainless steel pin provided. It can fully rotate 270 degrees and lay flat on the dock. This is a favorite of people concerned with keeping the steps clean of marine growth.



LIFT LADDER 3-7 STEPS

This is our #2 selling ladder. This ladder design allows the user to lower the rungs of the ladder into the water and retract them not in use. When fully retracted the lower steps should be out of the water preventing build-up of marine growth. It is a favorite of consumers in both salt and fresh water applications.



**FOR SELECTION GUIDE AND SHIPPING INFORMATION VISIT:
WWW.DOCKPRODUCTS.COM**



LADDERS

FLOATING DOCK LIFT LADDER 3-7 STEPS

This is a must have ladder if you are working with a floating dock for your boat. Different from our standard lift ladder, this specialty model rests in the lift position only 12 inches from the top of the dock keeping it free of marine growth in almost all situations. When deployed, the first step is even with the top of the dock which is different than our other models.

FINGER PIER LIFT LADDER 3-7 STEPS

The Finger Pier Lift Ladder has all of the space-saving features of our standard version, plus the design allows the user to lower the rungs of the ladder into the water and retract them when not in use. When fully retracted the lower steps should be out of the water preventing build-up of marine growth.

FINGER PIER LADDER 3-7 STEPS

This unique ladder is designed to be installed at the end of a finger dock. The oversized handrails, common on our other dock ladders, are replaced with space-saving right and left vertical hand grips. This ladder is a smart choice when space on the dock is at a minimum.

ALL LADDERS HAVE SERRATED NON SKID RUNGS



ALL LADDERS HAVE A 665 LB. CAPACITY

WIDE STEP MODELS SHOWN



LADDER FEATURES AND OPTIONS

PRECISION CONSTRUCTION

State-of-the-art robotic welding allows International Dock to respond quickly to the needs of our customers. With this technology we can accurately and consistently complete as many as 10 individual welds per minute resulting in better inventory control at lower costs. Meeting or exceeding our customer's expectations for on time delivery of quality products at competitive pricing is always our goal.

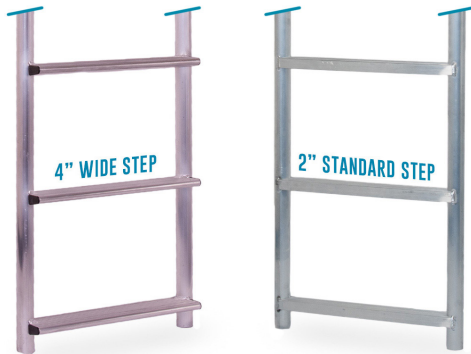
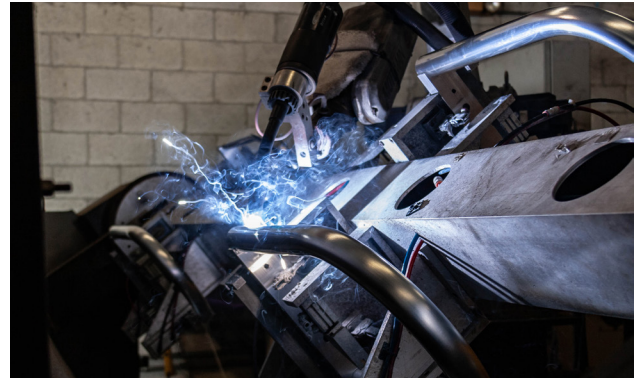

OPTIONAL WIDE STEP

Our standard ladder steps measure approximately 2" deep and 16" wide. Recently our customers have requested a deeper step for stability and comfort. Simply specify "Wide Step Model" and your ladder will come with all steps measuring 4" deep and 16" wide. Both our 2" and 4" models will channel water away for a better grip when wet and are rated at 665 lbs.

QUICK RELEASE KIT

The Quick Release Kit allows effortless removal of ladder without tools. The kit comes with two aluminum bars to be bolted to the dock. After installation place that ladder over the bar and quick release studs. Simply secure ladder over the studs with the locking pins provided. For docks in colder regions this is an outstanding option if the ladders need to be removed at the end of the season.

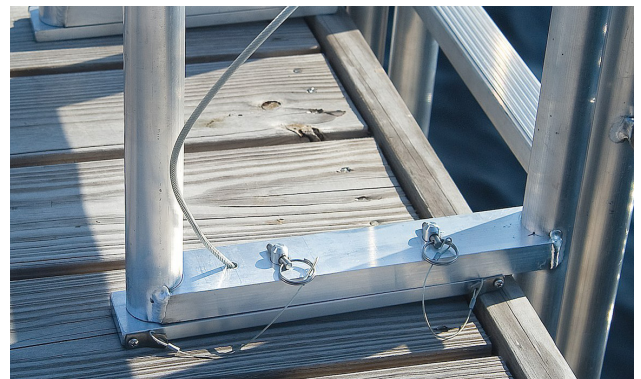

BOXED LADDERS FOR INDIVIDUAL SHIPMENT

To meet most shipping requirements we have developed a simple solution to economically ship individual ladders to our customers. Our shipping model has removable handrails that allows us to fulfill your needs at the lowest possible cost. When you receive the ladder simply insert the two handrails and secure them with the stainless steel bolts provided. This simple solution saves you shipping costs without sacrificing performance or durability.



**INTERNATIONAL
DOCK PRODUCTS, INC.**

FLEXMASTER DOCK PROTECTION

Protect your dock and your boat with our exclusive FlexMaster Dock Fenders. Made from a durable yet flexible extruded PVC material in both black and white. Standard profile can be purchased without any backing to be mounted on a 2 x 4 when and where you choose. Our most popular request is FlexMaster with our recycled plastic backing installed on either a 2 x 4 or 4 x 4 board. We use stainless steel fasteners along the full length and complete the assembly with a finishing top cap. With or without backing, FlexMaster is sold by the foot and quantity discounts are available. Available in lengths from 2 – 16 feet.

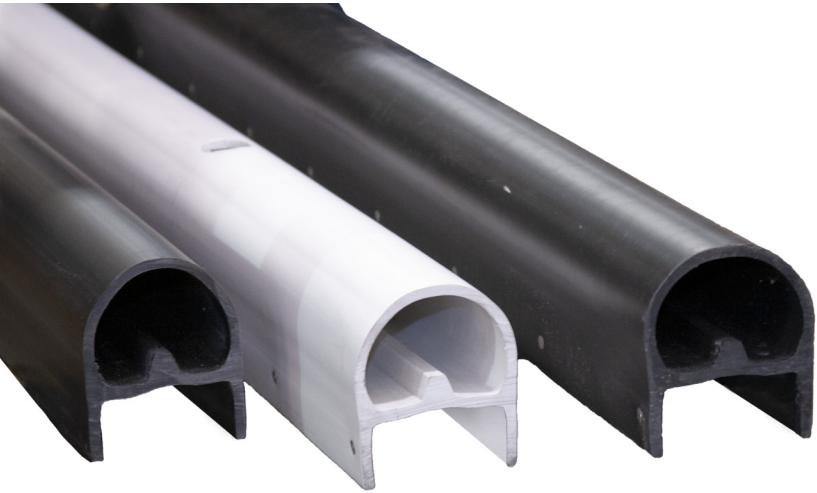

FLEXMASTER AVAILABLE
IN 2'-16' LENGTHS

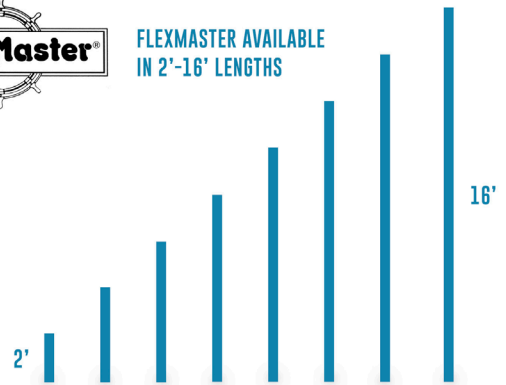

AVAILABLE IN 2-16 FT LENGTHS

FlexMaster Dock Fenders come in any length from 2 – 16 feet in both black and white. Fenders may be ordered mounted on a 2 x 4 recycled plastic board with finishing cap on top (mounted fenders come with pre-drilled holes for easy attachment to pilings) or can be ordered as the extended profile only.

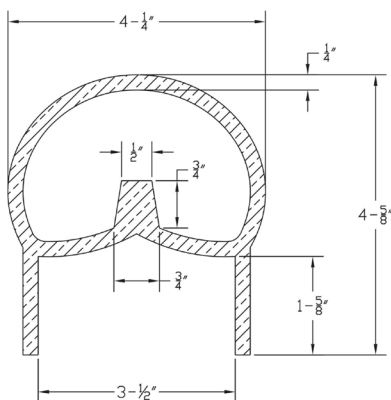
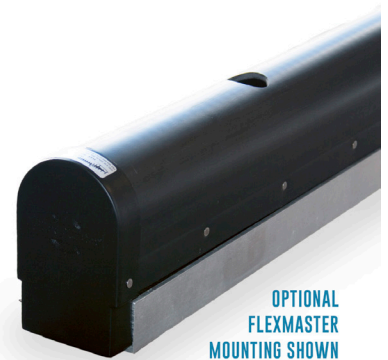

FENDER BRACKETS

Our custom sized fender brackets are welded from heavy duty aluminum channel, the brackets are designed to fit FlexMaster Fenders mounted on a 4 x 4 exactly. When ordering simply give us the total length you need and how many feet above and below the dock it needs to protect. Mount these brackets between pilings to solve the problem of smaller boats and PWC's getting damaged when they slip under the dock. Brackets and Flexmaster Fenders are sold separately by the foot.



**INTERNATIONAL
DOCK PRODUCTS, INC.**

DOCK ACCESSORIES



PILING CAPS

- Individually molded in UV resistant PVC
- Available in black or white
- Gives your dock or marina that “professional finished look”
- Protects wooden pilings from premature internal rot
- Choose round or square designs
- Available flat or cone shaped in all sizes
- Availability in ½” diameter increments for perfect fit
- Cone shape discourages pesky birds



HOSE AND CABLE HOLDERS

Always a popular accessory, keep your dock neat with our aluminum hose holders. Available in 2 sizes, the smaller model holds approximately 50 ft. of dock hose and the large version handles 100 ft. Our deluxe holder has a built-in ¼ turn hose spigot allowing you to have water at your fingertips at a comfortable height off the deck. Holders are available on a 30”h x 3” x 3” powder coated stanchion with or without the spigot as a great option when water is needed in several locations along your dock.



ALUMINUM DOCK CLEATS

International Dock supplies cleats to hundreds of retail stores, marinas and yacht clubs. Strong but light weight cleats are offered in 10”, 12”, 15” and 20”. The “S” cleat is unique for its design allowing a boat handler to tie down a boat quickly. The offset bolt holes allow for easy and quick installation. As are many of our accessories, quantity discounts are available on our entire cleat line to qualified Marinas. Sold in white powder coated or natural finish.



LINE HANGERS

Available in pressure treated wood or super durable recycled black plastic, our line hangers are a convenient answer for keeping lines out of the water or within reach when docking. We offer quantity discounts to Marinas that are adding new hangers to a large number of boat slips.



INTERNATIONAL DOCK PRODUCTS, INC.

EVERY ACCESSORY FOR TODAY'S DOCK, EXCEPT THE BOAT!



Flex Master[®]

WHAT SETS US APART

International Dock products has been manufacturing high quality marine dock accessories for over 30 years. Based in South Florida, this second generation family run business remains committed to producing high quality dock accessories for consumers, retailers, marinas, yacht clubs, and professional dock builders.

OUR HISTORY

International Dock Products, Inc. was established in 1995 as a result of a merger between S. King Fulton, Inc. and Flexmaster, Inc.

Both companies were successful marina accessory manufacturers / distributors for many years. S. King Fulton, Inc. had been manufacturing electrical power centers and other dock accessories for over 30 years. Flexmaster, Inc. had been manufacturing Flexmaster Dock Fenders and other accessories for over 10 years.

Our high-quality manufacturing process and our commitment to superb customer service has allowed International Dock Products to emerge as a leader in the dock accessory industry.

WEB | DOCKPRODUCTS.COM

EMAIL | INFO@DOCKPRODUCTS.COM

PHONE | (800) 909-DOCK (3625)

(954) 964-5315

FAX: (954) 964-2715

LOCATION | 3101 S.W. 25TH STREET, BAY 106

PEMBROKE PARK, FLORIDA 33009 USA

**“EVERY ACCESSORY FOR TODAY'S DOCK,
EXCEPT THE BOAT!”**

INTERNATIONAL DOCK PRODUCTS | (800) 909-DOCK | INFO@DOCKPRODUCTS.COM